



TREEKEEPER™
WWW.TREEKEEPERBAGS.COM

For assistance with assembly or installation, parts and customer service:
www.TreeKeeperBags.com/Help | Support@VillageLighting.com

PRO XL UPRIGHT TREE BAG

MODEL #: TK-10264-RS
PATENT NO. US 7,694,494 B2

PARTS :

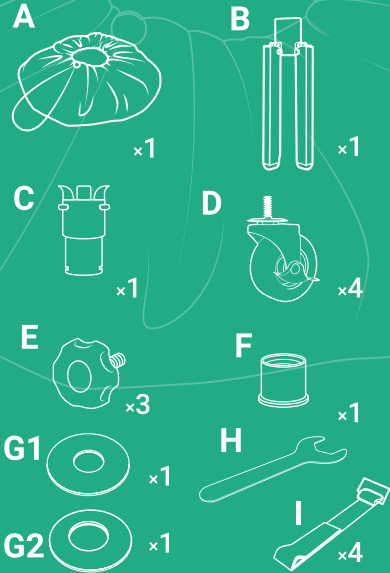

IMPORTANT, RETAIN FOR FUTURE
REFERENCE:
READ CAREFULLY

Intended for indoor use

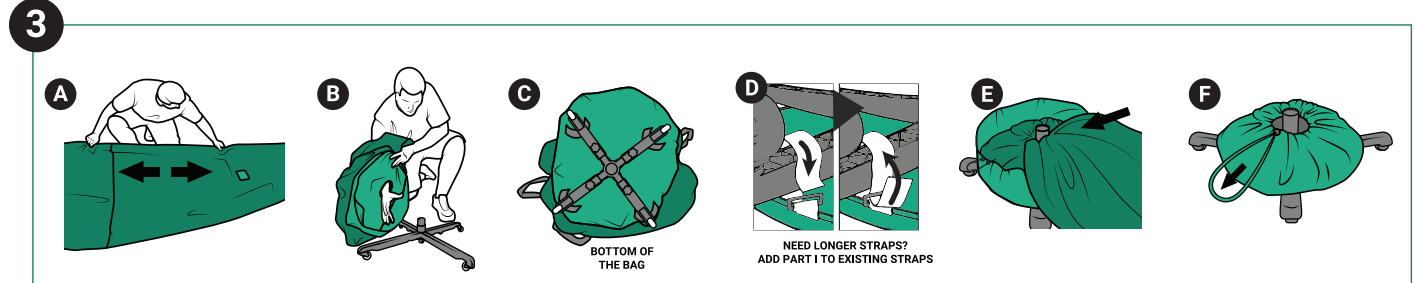
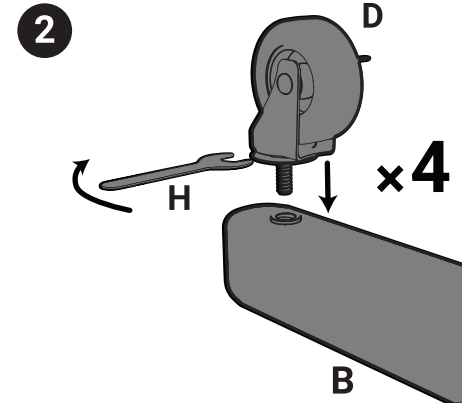
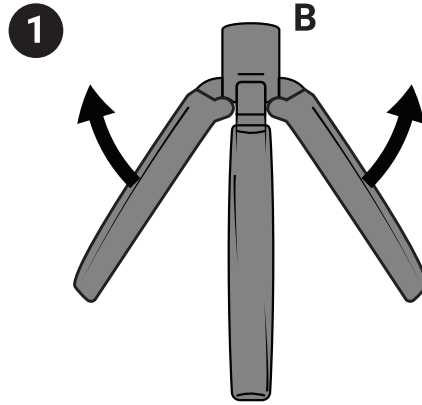

4 IMPORTANT: ASSEMBLY VARIES BY TREE POLE SHAPE AND SIZE. PLEASE FOLLOW INSTRUCTIONS BELOW

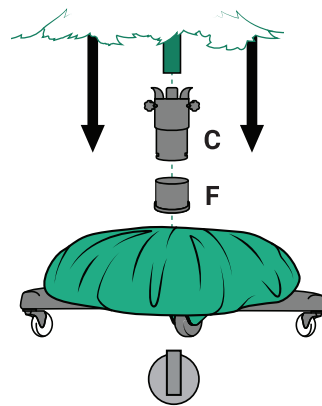

ALL SIZES FLAT BOTTOM, OR
LESS THAN 1.25" DIAMETER POLE

INSERT PART "F" INTO THE CENTER OF THE STAND UNDER PART "C"

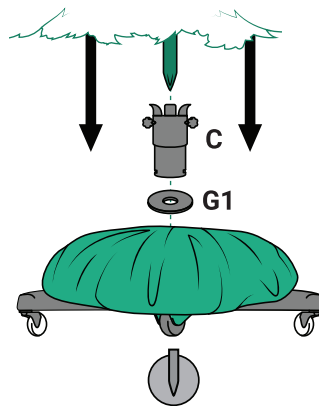

1.25" - 1.5" DIAMETER
POINTED POLE (G1)

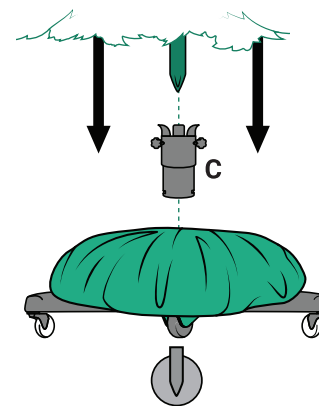

1.5" - 1.75" DIAMETER
POINTED POLE

NO ADDITIONAL PARTS NEEDED

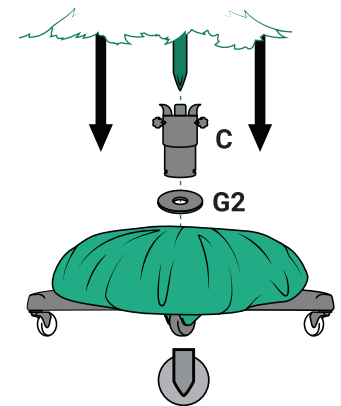

2+\"/>

INSERT PART "G" INTO THE CENTER OF THE STAND UNDER PART "C"

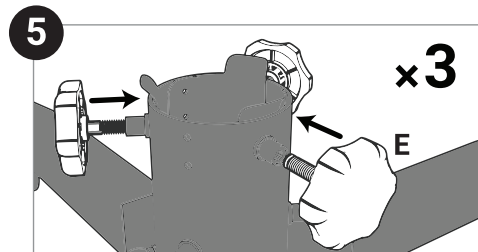

FOR BAG USAGE INSTRUCTIONS, PLEASE
CONTINUE TO THE NEXT PAGE

V 03133



TREEKEEPER™
WWW.TREEKEEPERBAGS.COM

For assistance with assembly or installation, parts and customer service:
www.TreeKeeperBags.com/Help | Support@VillageLighting.com

PRO XL UPRIGHT TREE BAG

MODEL #: TK-10264-RS
PATENT NO. US 7,694,494 B2

PARTS:

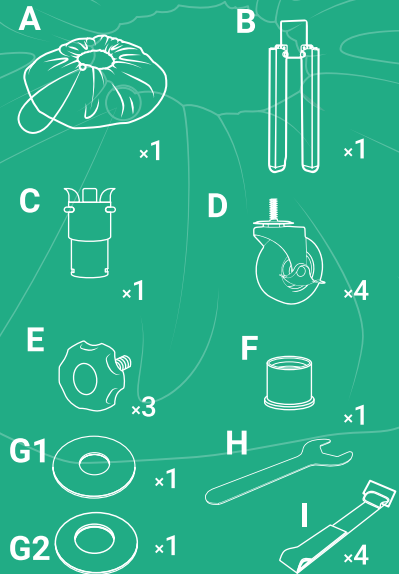

CAUTION



DO NOT lean the bag on its side and pull all the weight of the tree on one or two legs. Doing so could cause damage your tree stand, tree, or yourself. ALWAYS use caution when leaning the tree over. DO NOT put too much pressure on the stand while tipped as this could result in damaging the trunk of the tree. Use CAUTION when lifting the tree as it may be heavy. Use EXTREME CAUTION when moving the tree up or down stairs. Whenever possible, USE TWO OR THREE PEOPLE TO STORE YOUR TREE.

SETUP INSTRUCTIONS

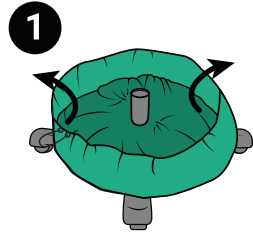

1
OPEN THE OUTER (LOWER) SKIRT

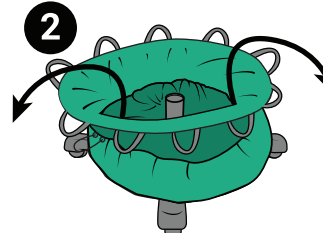

2
LOCATE AND PULL OUT THE TOP SKIRT OF THE BAG AND LAY FLAT AROUND THE TREE

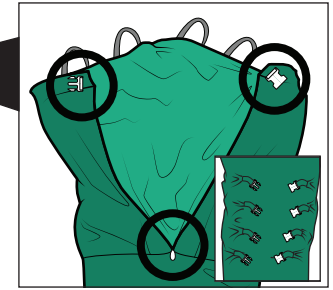
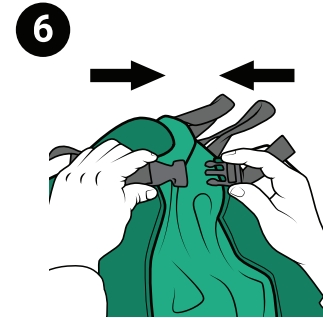
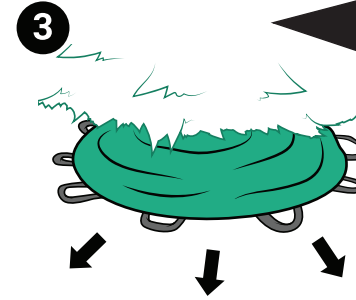

INSURE ALL BUCKLES, DRAWSTRINGS AND ZIPPERS ARE OPEN BEFORE PULLING UP



4
ADJUST BAG IF IT SNAGS OR TWISTS, THEN CONTINUE TO PULL UP

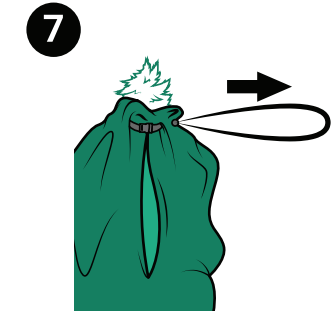
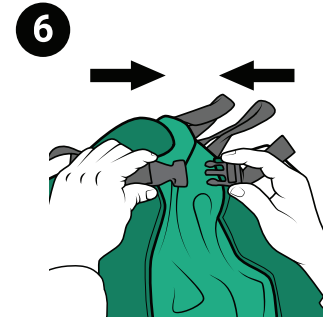
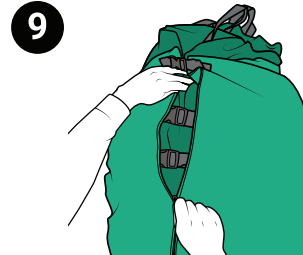
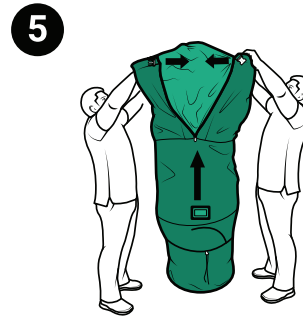

7
FOR TREES ABOVE 7.5FT IT'S RECOMMENDED YOU TAKE THE TREE TOP OFF AND STORE IT IN THE LOWER AREA OF THE BAG.

TAKEDOWN INSTRUCTIONS

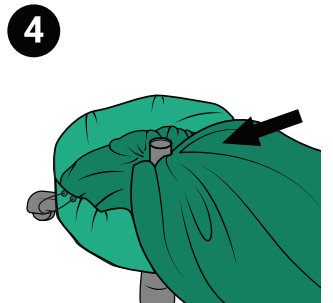
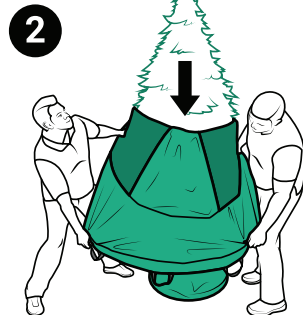
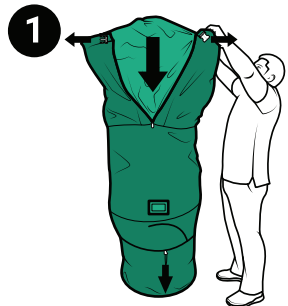

3
GENTLY PUSH IN THE BRANCHES THAT GET CAUGHT ON THE INTERIOR BAG AND CONTINUE TO PULL DOWN

TREE BAG TROUBLESHOOTING, TIPS & FAQ

MODEL #: TK-10264-RS
PATENT NO. US 7,694,494 B2

HOW THE UPRIGHT TREE BAG WORKS

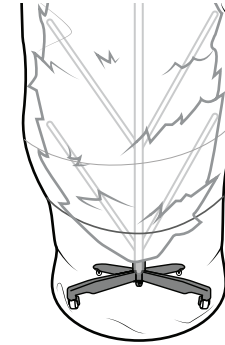
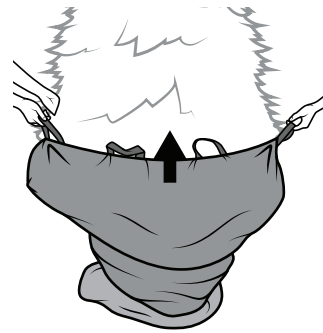

The bag pushes up on the hinged branches and compresses them into a vertical position. Sometimes the bottom branches are the hardest to get started because they're the largest.

MY TREE PULLS OUT OF STAND WHEN TRYING TO PULL THE BAG UP.



Make sure the collar knobs are very tight.

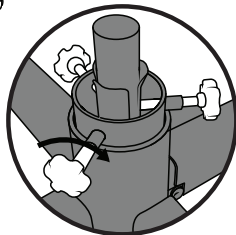

DOES IT SEEM LIKE YOUR BAG IS TOO SMALL?



Always Use 2 People



Make sure that all of the buckles, zippers and straps on both sides are undone.



Start by pulling up on one side first, then work your way around to the other side.

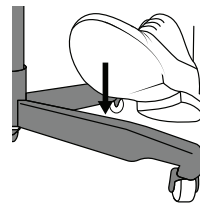

Apply pressure to the stand to keep it stable when pulling up.



Make sure the bag is not twisted when pulling up. Untwist and continue to pull up.

MY BAG IS STUCK! I CAN'T PULL IT DOWN TO SKIRT POSITION.



Let the skirt hang down as far as it can.



Make sure all the Buckles, Zippers and straps are opened.

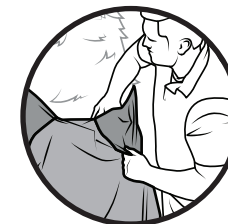

Reach your hand inside the bag and press the branch tips inward and tug down the bag to free it from the branches. Repeat this step and work your way around the tree.